

NATIONAL ASSEMBLY

SECOND SESSION

THIRTY-FIFTH LEGISLATURE

Bill 152

(1997, chapter 60)

An Act respecting the reconstruction and redevelopment of areas affected by the torrential rains of 19 and 20 July 1996 in the Saguenay — Lac-Saint-Jean region

Introduced 17 June 1997
Passage in principle 17 June 1997
Passage 17 June 1997
Assented to 19 June 1997

EXPLANATORY NOTES

The purpose of this bill is to enable the Minister of Transport to acquire by agreement or by expropriation on behalf of the Government such property as is necessary for the reconstruction and redevelopment of areas affected by the torrential rains of 19 and 20 July 1996 in the Saguenay — Lac-Saint-Jean region. To that end, the bill shortens certain periods prescribed by the expropriation procedure but retains the usual rules relating to compensation.

The areas concerned by the bill are situated within a perimeter defined by means of maps appended to the bill which are reproduced in a larger scale document tabled as a Sessional Paper in the National Assembly.

As regards the carrying out of the work, the bill provides an express right of passage over private property, subject to compensation for damage sustained by the owners. It also enables a municipality to carry out reconstruction and redevelopment work on behalf of the Government or a government department.

Lastly, the bill provides for certain exclusions in reference to the application of the Act respecting land use planning and development and the Act to preserve agricultural land.

Bill 152

AN ACT RESPECTING THE RECONSTRUCTION AND REDEVELOPMENT OF AREAS AFFECTED BY THE TORRENTIAL RAINS OF 19 AND 20 JULY 1996 IN THE SAGUENAY — LAC-SAINT-JEAN REGION

THE PARLIAMENT OF QUÉBEC ENACTS AS FOLLOWS :

1. The Minister of Transport may, on behalf of the State, acquire by agreement or by expropriation any immovable the Minister considers necessary for reconstruction or redevelopment in the areas affected by the torrential rains of 19 and 20 July 1996 within the perimeters shown on the maps reproduced in the schedules and, on a larger scale, in Sessional Paper No. 1019-970617 tabled in the National Assembly on 17 June 1997.

Such immovables may include :

(1) the former and new bed of a watercourse or the immovables required for its relocation as well as the riparian land ;

(2) islands formed in the new bed of a watercourse or resulting from the formation of a new branch cutting riparian land, and land enclosed as a result of a change in the bed of a watercourse ;

(3) immovables whose occupancy must be restricted by reason of the danger of flood, rockfall or landslide or for reasons of public safety or environmental protection regarding banks, shores, littoral zones or floodplains ;

(4) immovables to be used for the carrying out of work or the construction of structures on behalf of the Government or a government department, immovables on which such work or construction has been carried out, or immovables flooded as a consequence of the carrying out of such work or construction ;

(5) immovables containing material necessary for reconstruction or redevelopment ;

(6) immovables to be used for the relocation of persons forced to abandon their own immovables ;

(7) immovables adjacent to a damaged immovable so as to restore the use made thereof prior to 19 July 1996 or, if that use cannot be restored, to allow for another type of occupancy of the immovable ;

(8) real rights affecting an immovable.

The acquisition may also extend to movables if they are accessory to the immovables to be acquired.

2. The Minister shall make a copy of the Sessional Paper available for consultation in a public place in the localities in which the areas concerned are located; in addition, the Minister shall cause a notice indicating the places, period, days and time at or on which the Sessional Paper may be consulted to be published in a newspaper circulated in those localities.

3. The Minister may, subject to the conditions he determines, transfer, lease or exchange any property acquired pursuant to section 1 or any property built as part of the reconstruction or redevelopment of the areas referred to in that section, or may otherwise dispose of the property.

4. Any person carrying out reconstruction or redevelopment work on behalf of the Government or a government department in areas referred to in section 1 may enter upon any property if entry is necessary for the carrying out of the work.

An owner bound to allow entry upon his property is entitled to compensation for any damage he sustains as a result of that sole fact and to the restoration of his immovable to its former condition.

5. Sections 6 to 14 apply to every expropriation authorized by this Act and for which no notice of expropriation was served pursuant to section 40 of the Expropriation Act (R.S.Q., chapter E-24) before 19 June 1997.

Unless otherwise provided by this Act, Title II of the Expropriation Act does not apply to such an expropriation.

6. Expropriation commences by the filing in the registry office of the registration division in which the immovables to be expropriated are situated of a general plan of the immovables signed by a land surveyor. The plan must be filed with a notice containing a description, the overall assessment of the immovables to be expropriated and a statement to the effect that registration of the notice filed with the general plan transfers ownership of the immovables described therein to the State.

Registration in the land register of the notice filed with the general plan transfers ownership of the immovables described therein to the State. The Minister may, however, within two years, amend the plan and the registered descriptions and every such modification shall have the same effect and shall be published in the same manner as the notice filed with the general plan. Withdrawal of an immovable from the plan before the taking of possession is equivalent to retrocession with the sole obligation of payment of the indemnities, if any, fixed by the Expropriation Division of the Court of

Québec. Withdrawal is effected by way of a notice describing the immovable retroceded under this section.

7. Where an expropriated immovable is charged with real rights registered in the land register of the registry office, the rights are discharged by registration of the notice filed with the plan; the same applies for actions in dissolution, in revendication or other real actions which are converted into personal claims against the expropriated party.

The effects of any forfeiture of term clause, including a resolutive clause, are extinguished and discharged by registration of the plan.

The registrar is bound by virtue of his office to cancel the discharged rights.

8. The Minister shall send, insofar as the expropriated party has been identified, by registered or certified mail or by any means he considers the most appropriate, a notice informing the expropriated party of the transfer of ownership, along with a request that the expropriated party, within such time as the Minister specifies, inform him in writing of the names and addresses of the lessees, the nature, date and term of and the rent for each lease and the names and addresses of occupants in good faith and the conditions on which they occupy the premises.

9. The Minister shall deposit for the benefit of the expropriated party, in the office of the Superior Court of the district in which the immovable to be expropriated is situated, a provisional indemnity of not less than 70% of the municipal assessment prior to 19 July 1996 or, if the immovable has not been so assessed, an amount the Minister considers appropriate. That amount shall be reduced by the amount of any financial assistance paid for the carrying out of work to restore the expropriated immovable to its former condition in the proportion of the work remaining to be carried out on the date of the sending of the notice required by section 8.

The clerk of the Superior Court shall issue to the Minister a receipt for the deposit of the provisional indemnity; the receipt shall mention the number of the lot in respect of which the indemnity was deposited and the name of the expropriated party for whose benefit the deposit was made, if he has been identified. In addition, the clerk shall perform the obligations imposed by the first paragraph of section 53.15 of the Expropriation Act and shall distribute the provisional indemnity in the manner provided in that section to creditors whose rights have been discharged in accordance with section 7. Section 53.16 of the Expropriation Act applies to the distribution.

10. The Minister shall, when he is informed that a lessee or an occupant in good faith occupies an expropriated immovable, deposit for the benefit of the lessee or occupant, in the office of the Superior Court of the district in which the immovable is situated, a lump sum equal to three months' rent according to the appreciation of the rental value of the expropriated property made by the Minister. In the case of a farming, commercial or industrial operation, an amount fixed by the Minister may be added to the lump sum.

11. The taking of possession of an immovable that, at the time the notice filed with the plan was registered in the land register, was being used for residential, farming, commercial or industrial purposes, may not take place before the Minister gives advance notice, by registered or certified mail or by any means the Minister considers the most appropriate, informing the expropriated party, the lessee or the occupant in good faith, as the case may be, of the date of the taking of possession and of the deposit of the provisional indemnity or lump sum made in his respect.

12. In a case of resistance to the taking of possession of an immovable to which this Act applies, section 56 of the Expropriation Act, adapted as required, applies.

13. Where no agreement on the final indemnity is reached, the Minister or the expropriated party may apply to the Expropriation Division to have the indemnity fixed.

The lessee or occupant in good faith of expropriated property may also apply to the Expropriation Division to have the indemnity owing to him fixed.

The rules of evidence and procedure applicable to the fixing of indemnities arising from the expropriation of immovables under the Expropriation Act apply to a proceeding brought under this section.

Sections 58 to 68 of the Expropriation Act, adapted as required, apply to the fixing of the indemnity; for the purposes of sections 64 and 66, the restriction provided for therein is a restriction applying to sections 6 to 14 of this Act. However, the value of the expropriated property shall be established without taking account of the change in value resulting from the torrential rains or the reconstruction or redevelopment work carried out on behalf of the Government or a government department.

14. Where the deposit of a provisional indemnity was not sufficient to discharge the debts secured by real rights registered before the registration of the general plan, the Minister may deposit the balance of the indemnity in the office of the Superior Court; in such a case, the clerk shall continue the distribution in the manner provided in section 53.15 of the Expropriation Act.

15. Any local municipality may, on behalf of the Government or a government department, carry out reconstruction or redevelopment work in areas referred to in section 1, even outside its own territory.

16. The Act respecting land use planning and development (R.S.Q., chapter A-19.1) does not apply in respect of any intervention of the Government or a government department within the meaning of section 149 of that Act with a view to the reconstruction or redevelopment of areas referred to in section 1.

17. The Act to preserve agricultural land (R.S.Q., chapter P-41.1) does not apply to alienations in favour of the State or to subdivisions effected for the purposes of this Act.

18. From the coming into force of the provisions of the Act respecting administrative justice (1996, chapter 54) conferring jurisdiction on the Administrative Tribunal of Québec to decide proceedings relating to the fixing of indemnities resulting from the expropriation of immovables, a reference to the Expropriation Division of the Court of Québec, wherever it appears in this Act, is a reference to that Tribunal.

19. Sections 4, 15 and 16 have effect since 19 July 1996.

20. This Act comes into force on 19 June 1997.

SCHEDULE 1

AREAS OF RECONSTRUCTION AND REDEVELOPMENT

À Mars River

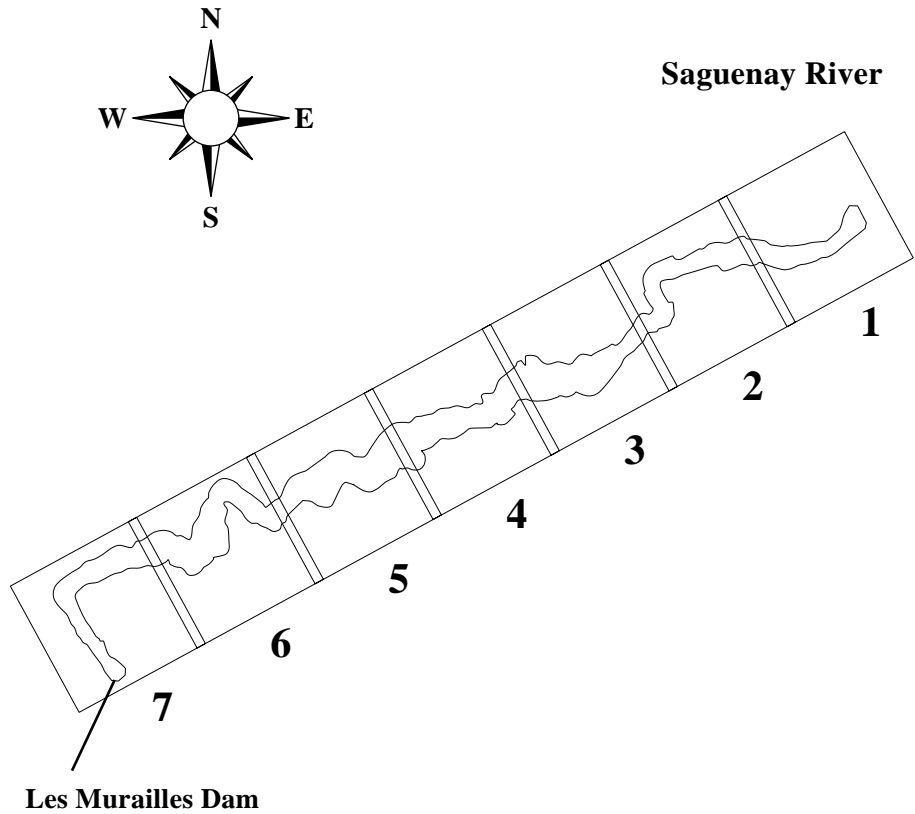

1



2



3



4



5



6

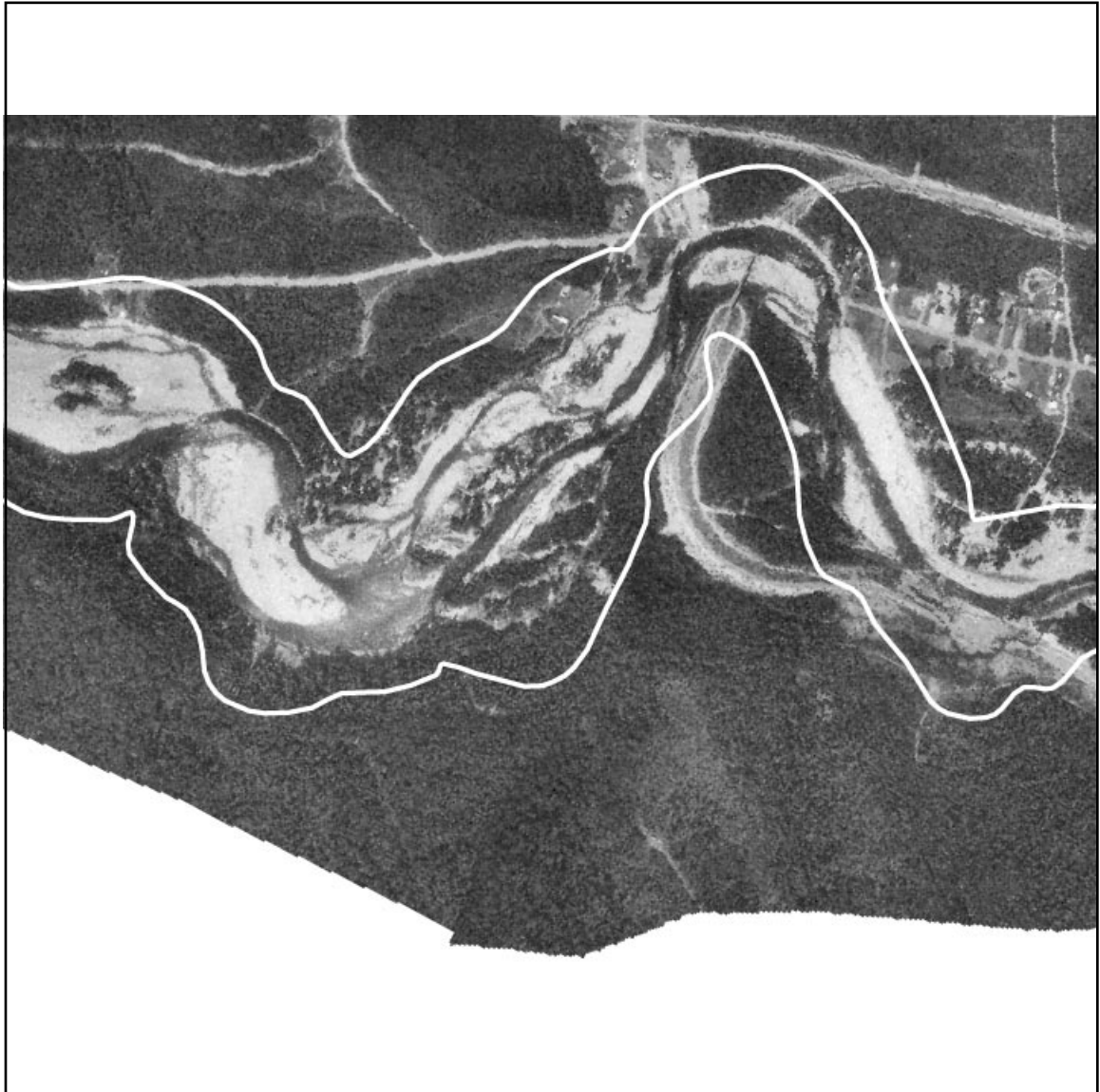

7

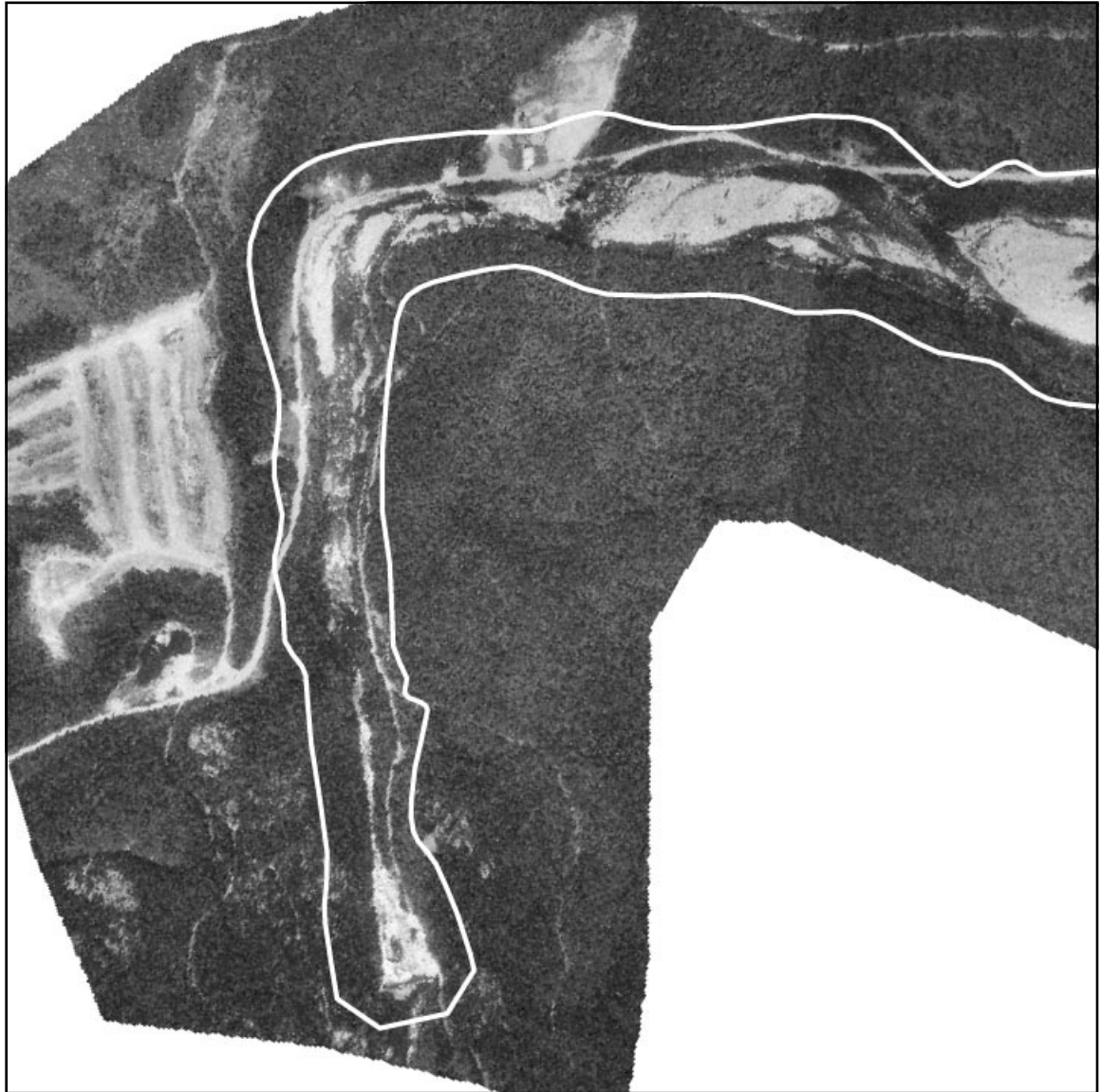

SCHEDULE 2

AREAS OF RECONSTRUCTION AND REDEVELOPMENT

Ha! Ha! River

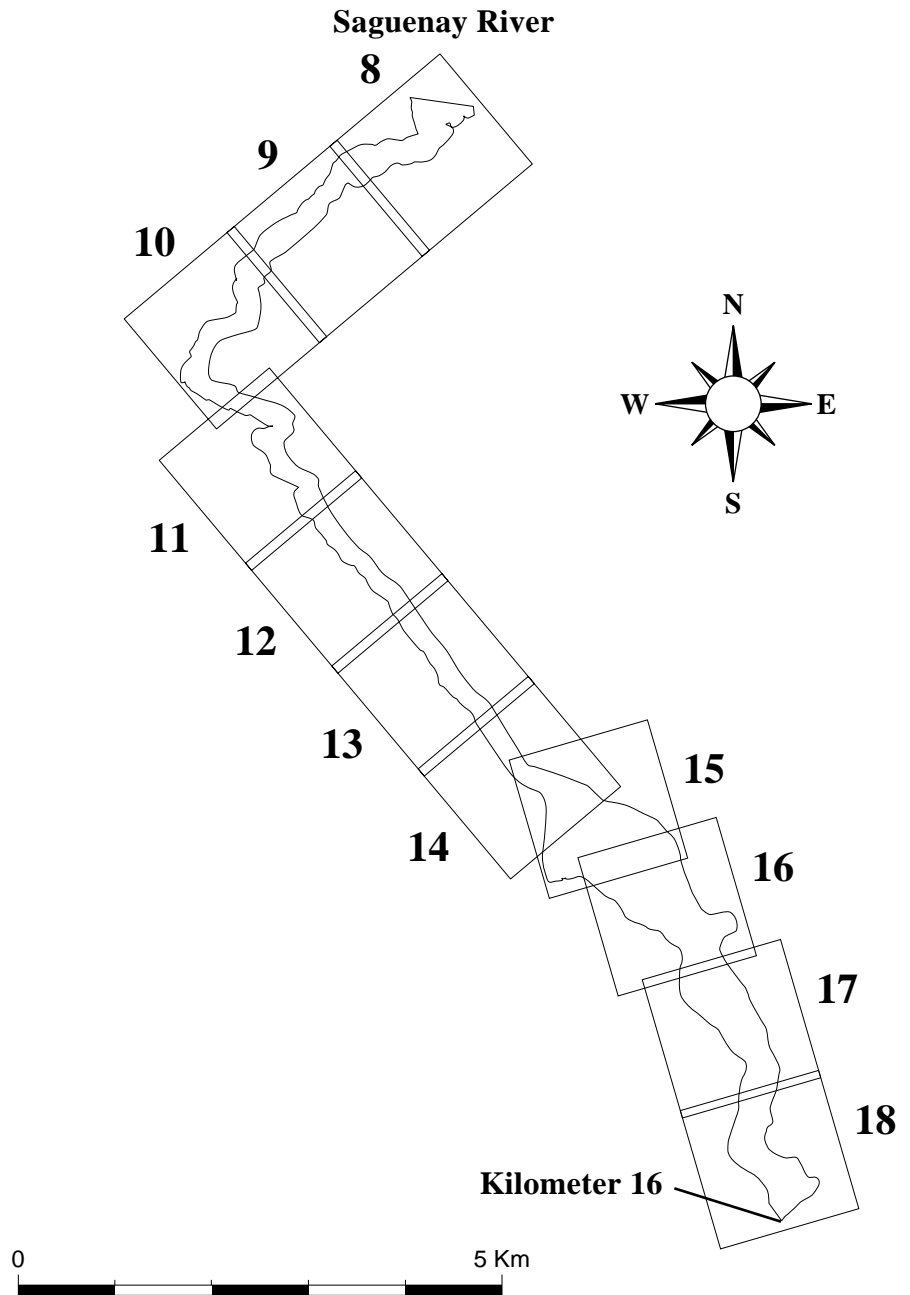

8

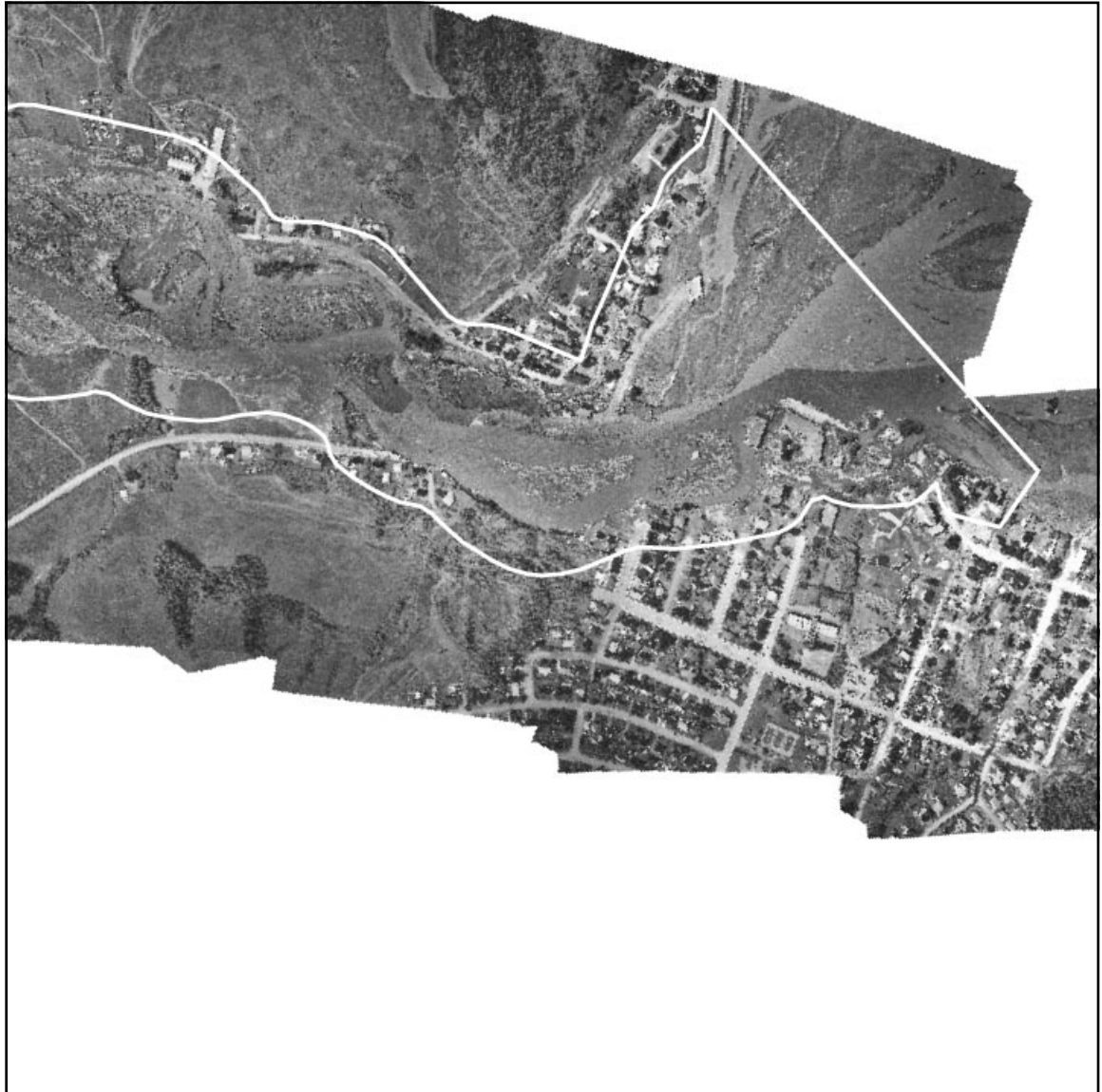

9



10



11

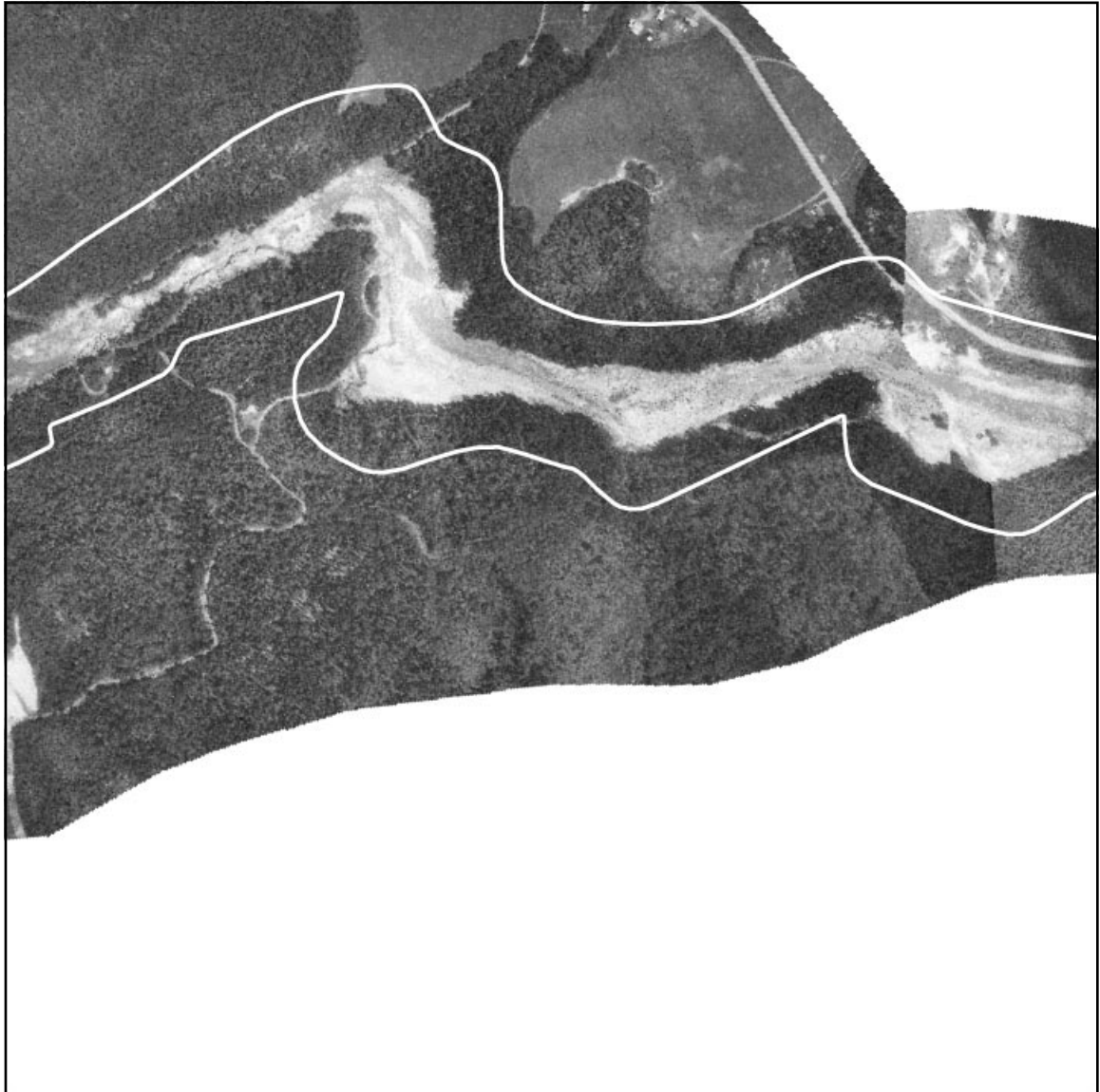

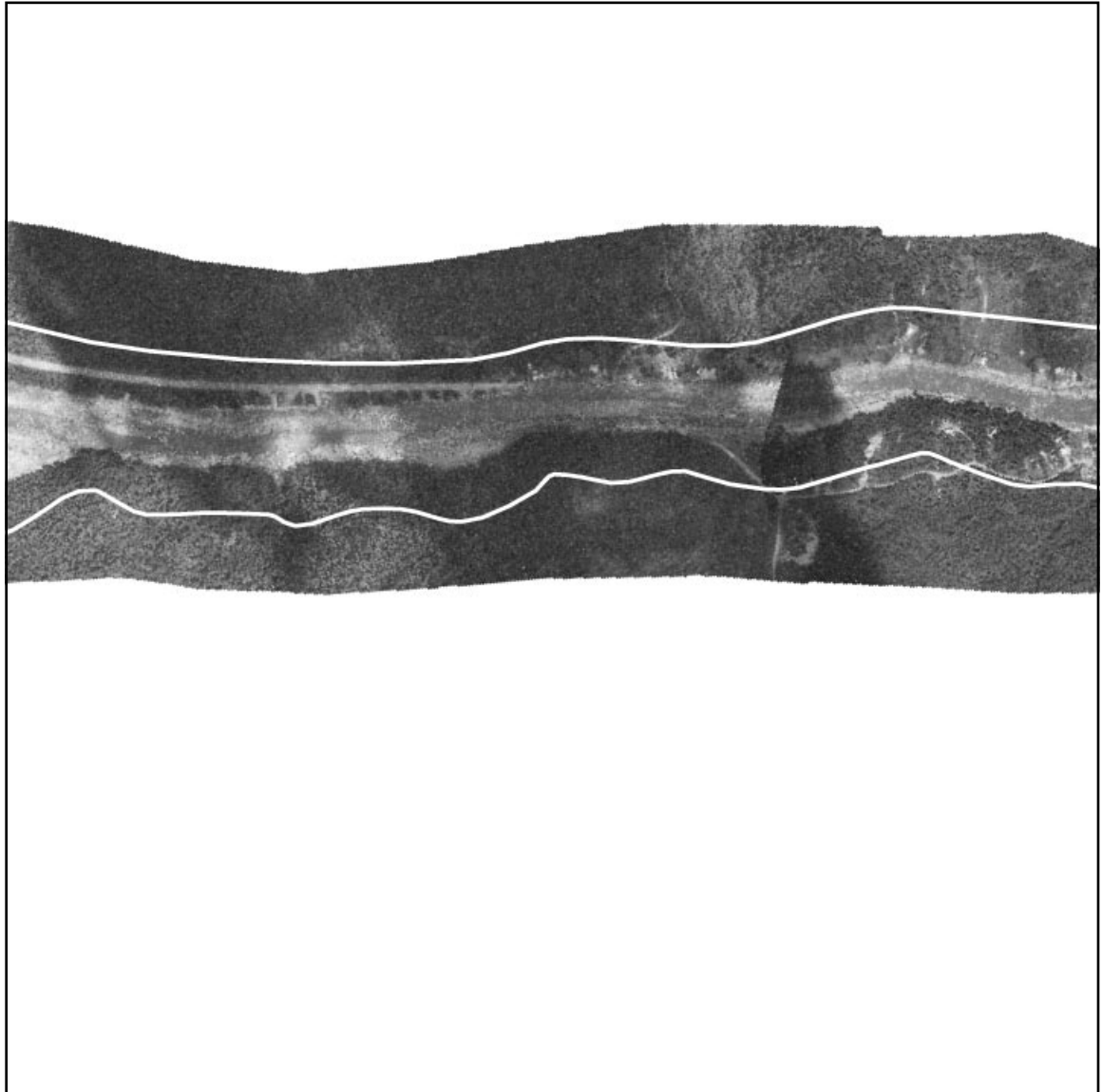
12

13

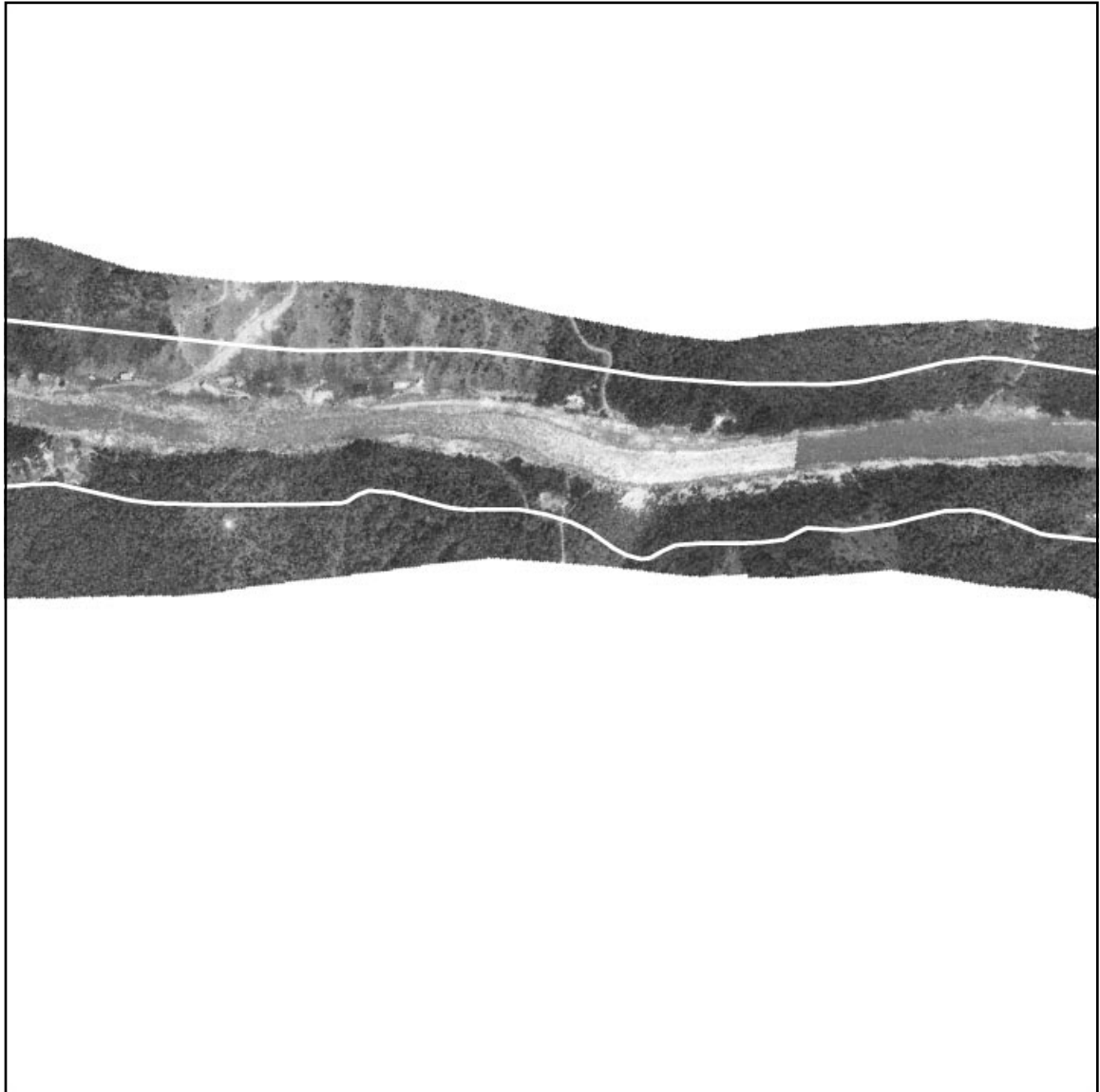

14



15



16

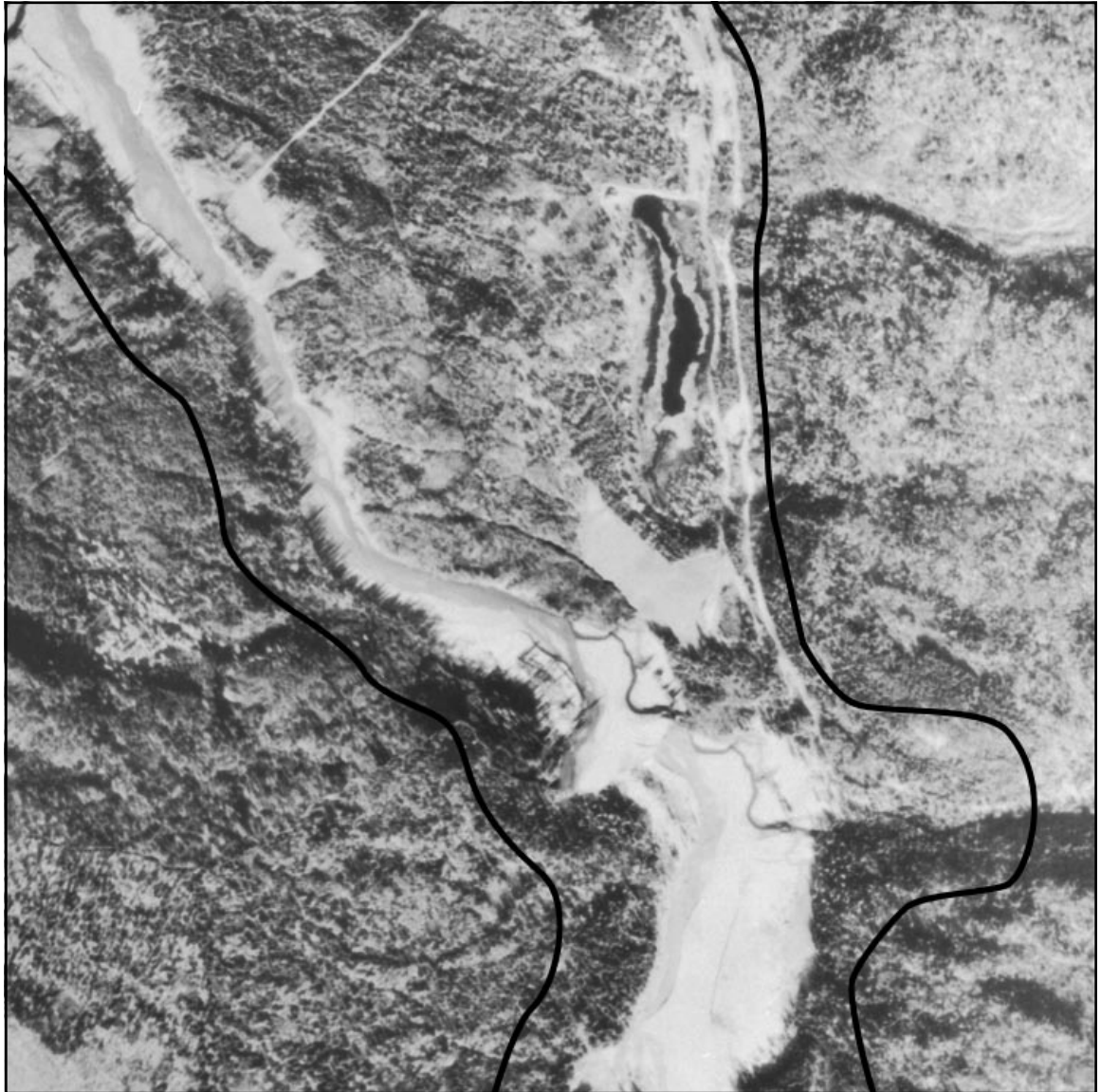

17

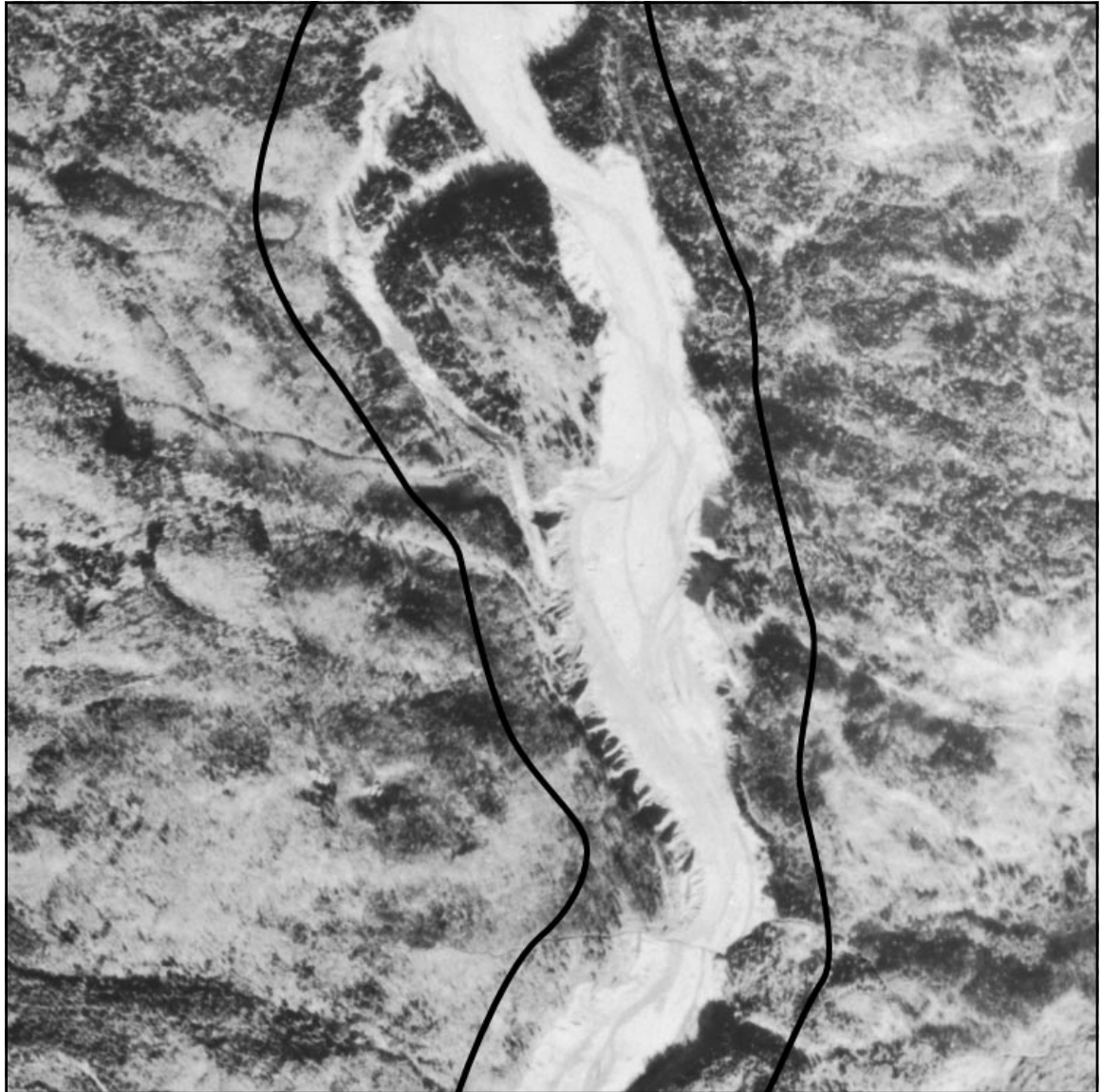

18

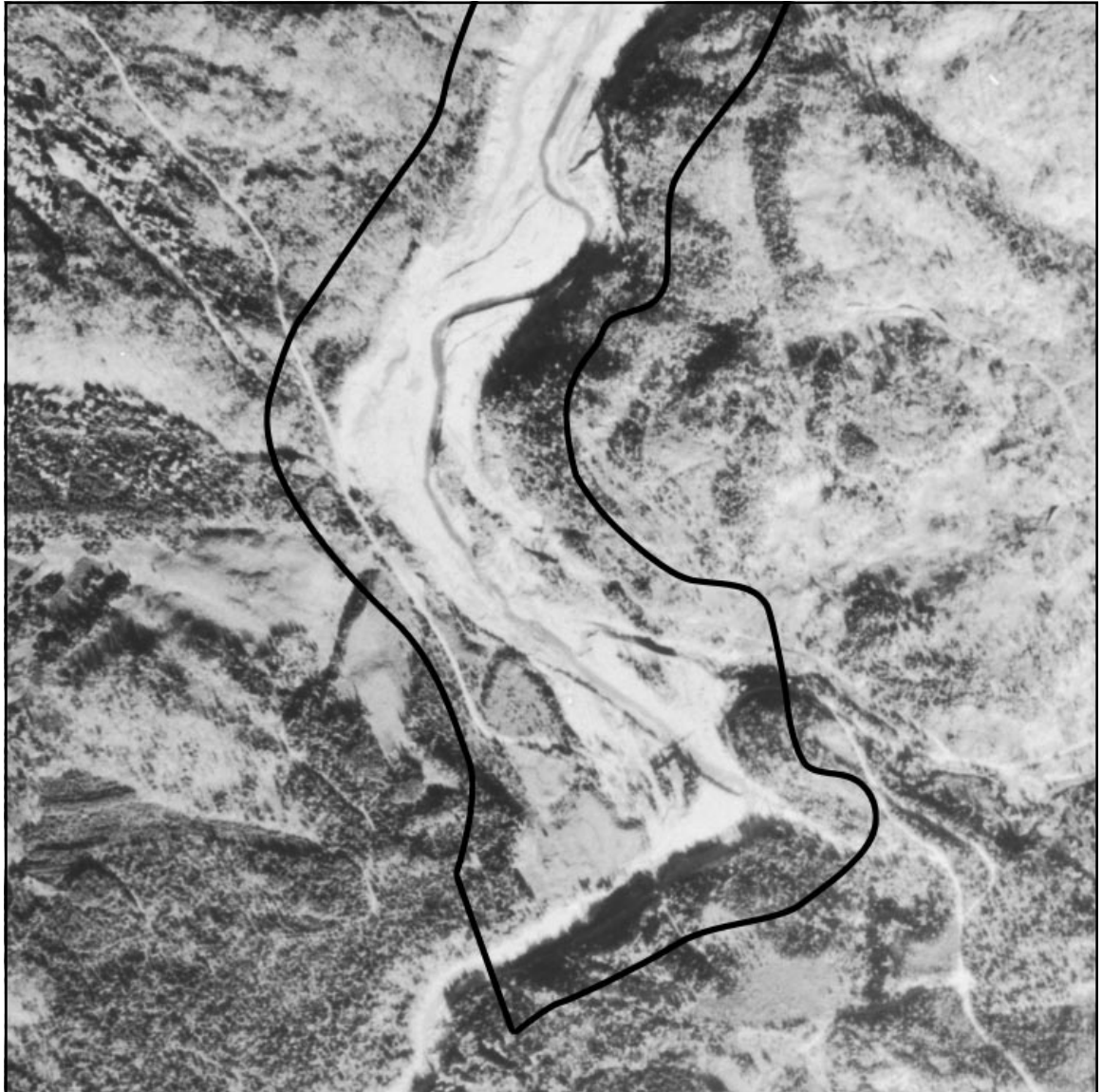

SCHEDULE 3

AREAS OF RECONSTRUCTION AND REDEVELOPMENT

St-Jean River

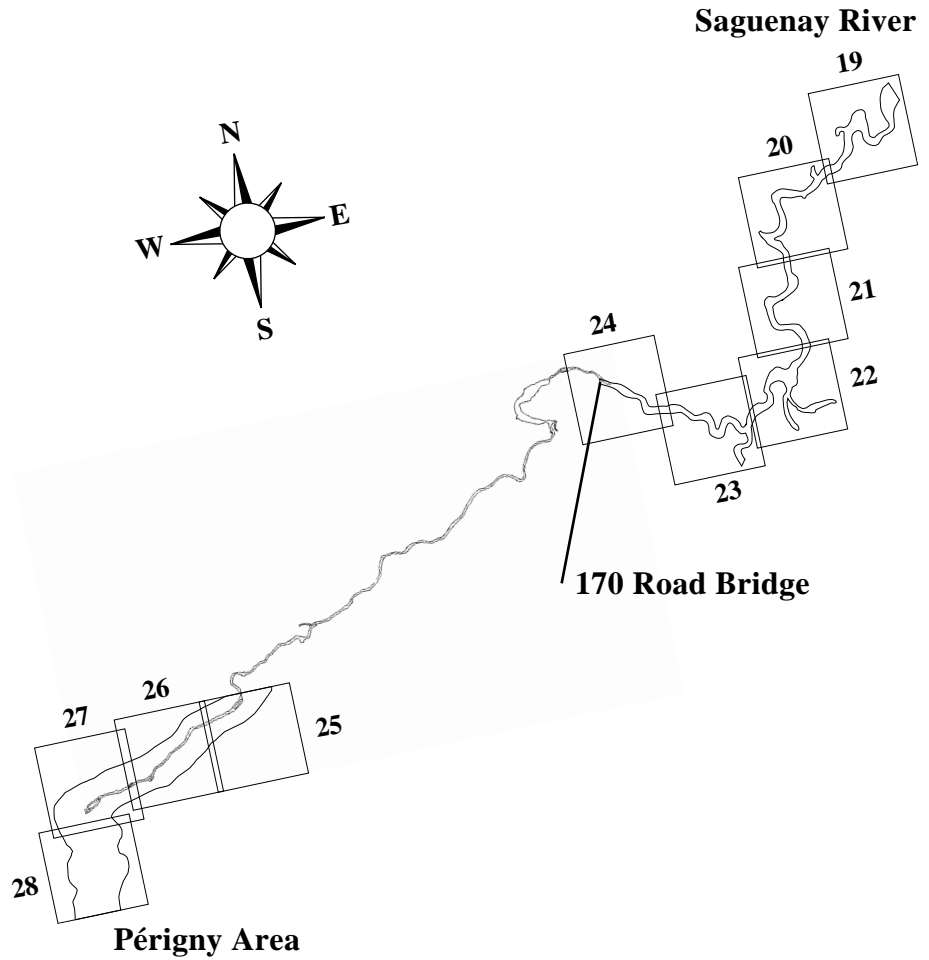

19

20

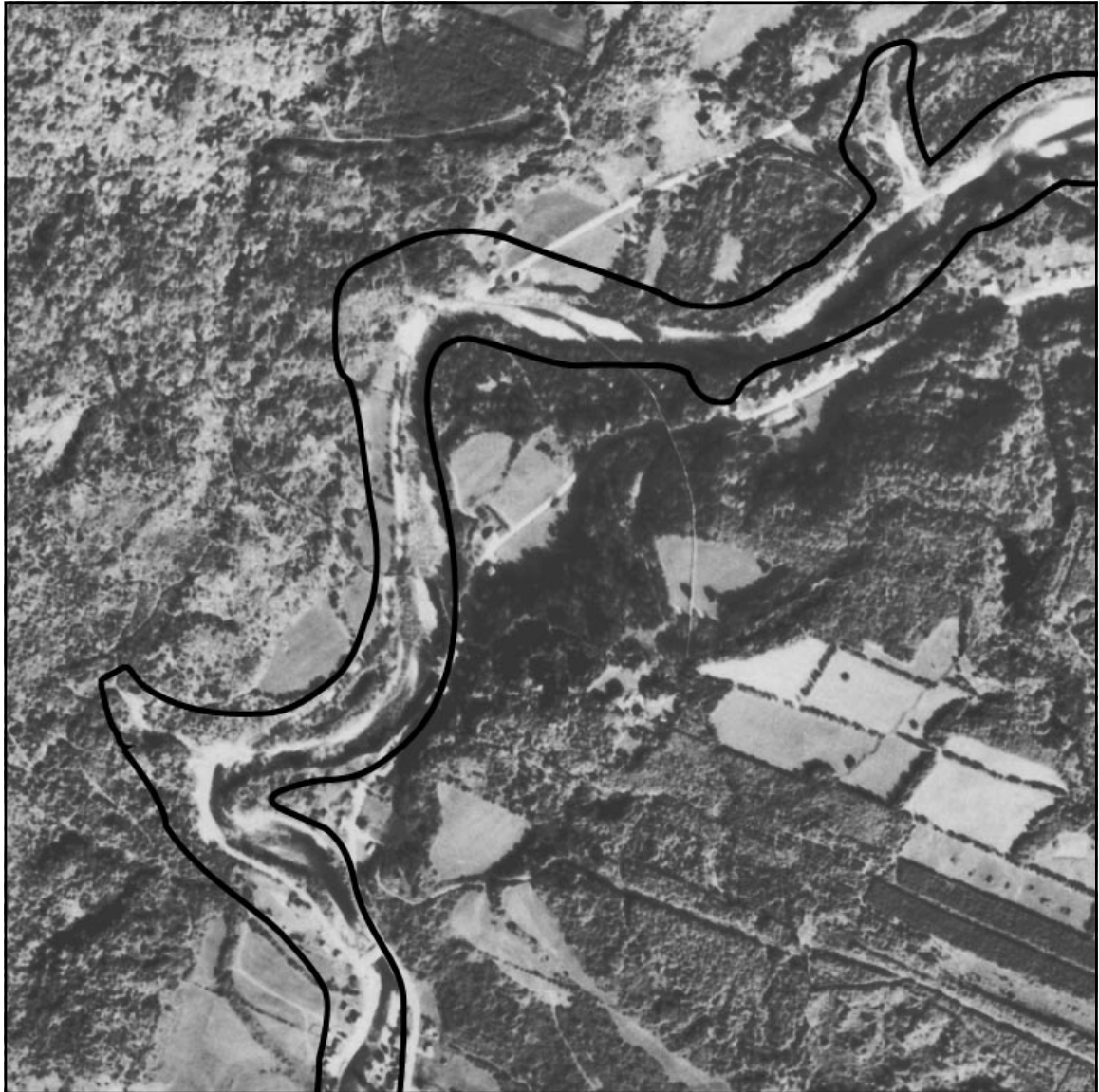

21

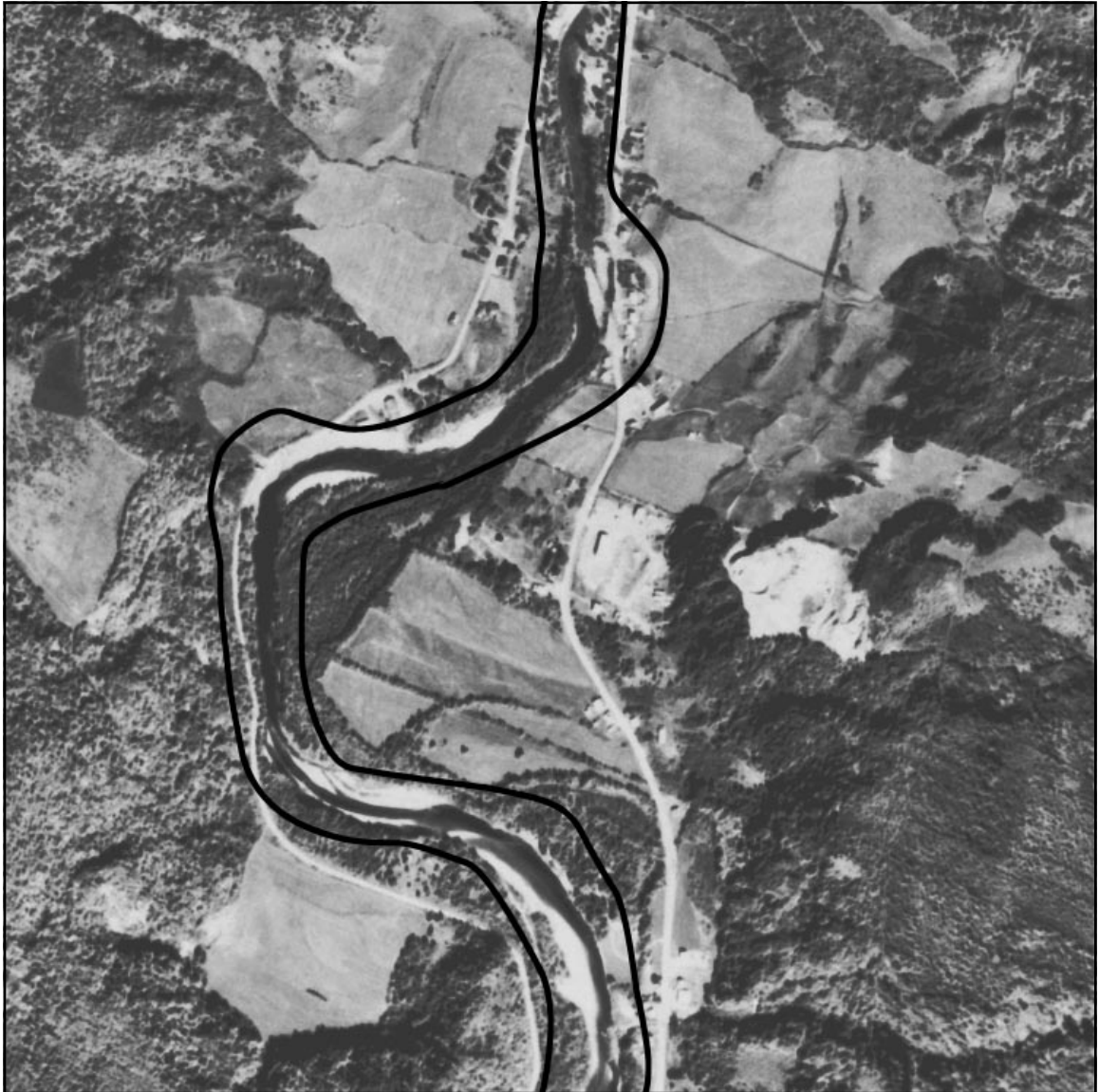

22

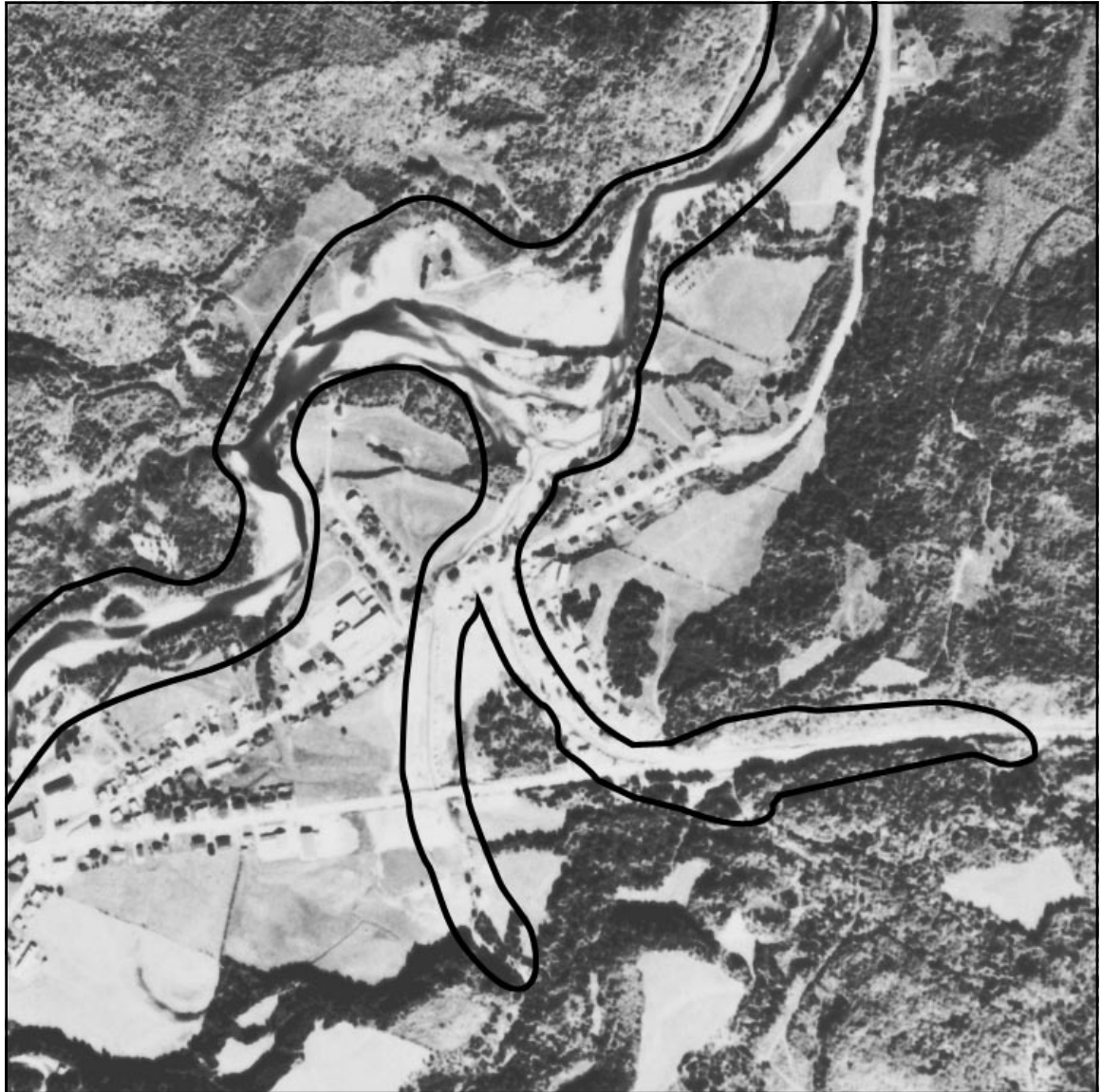

23



24



25

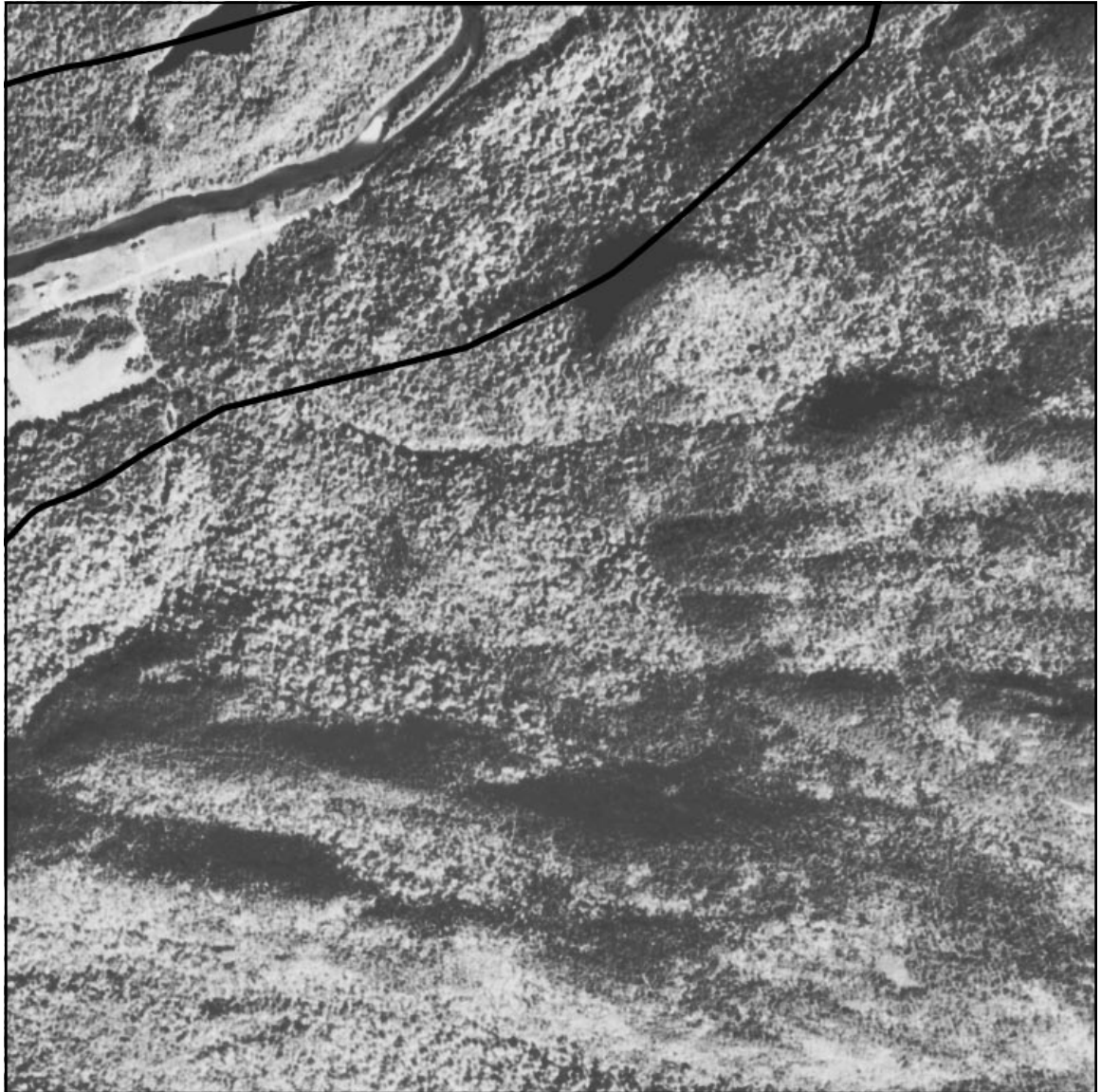

26

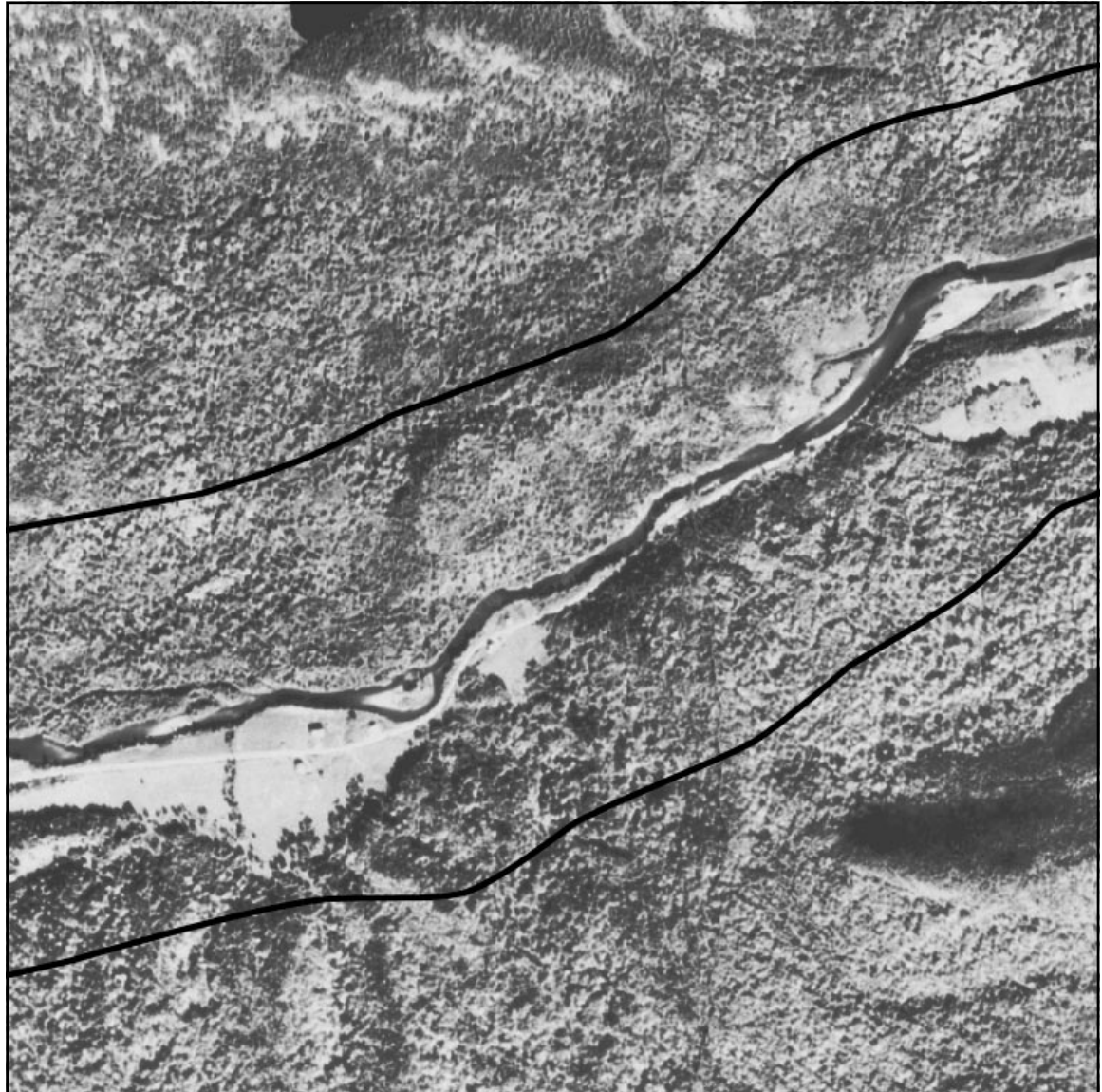

27

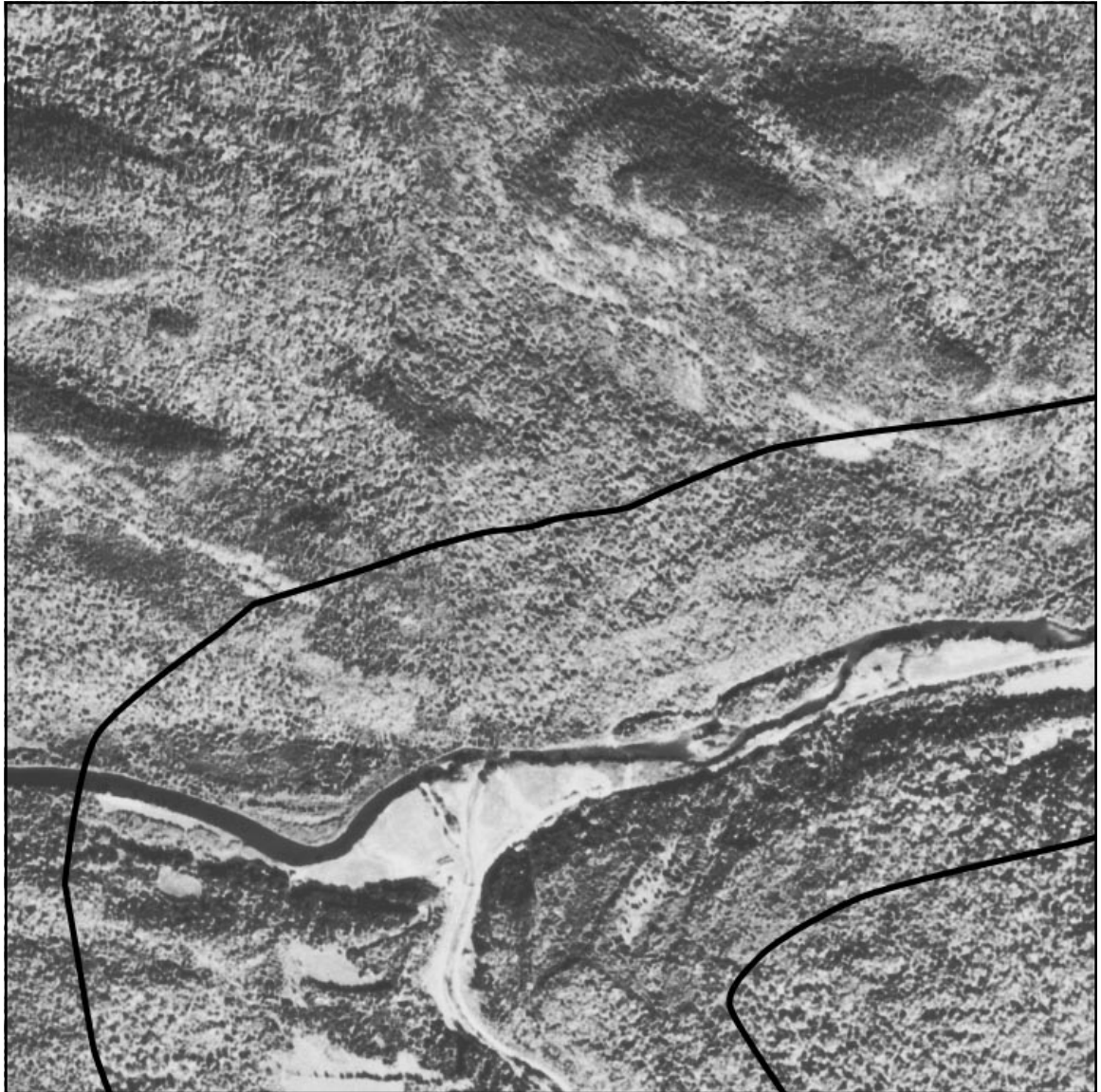

28

